

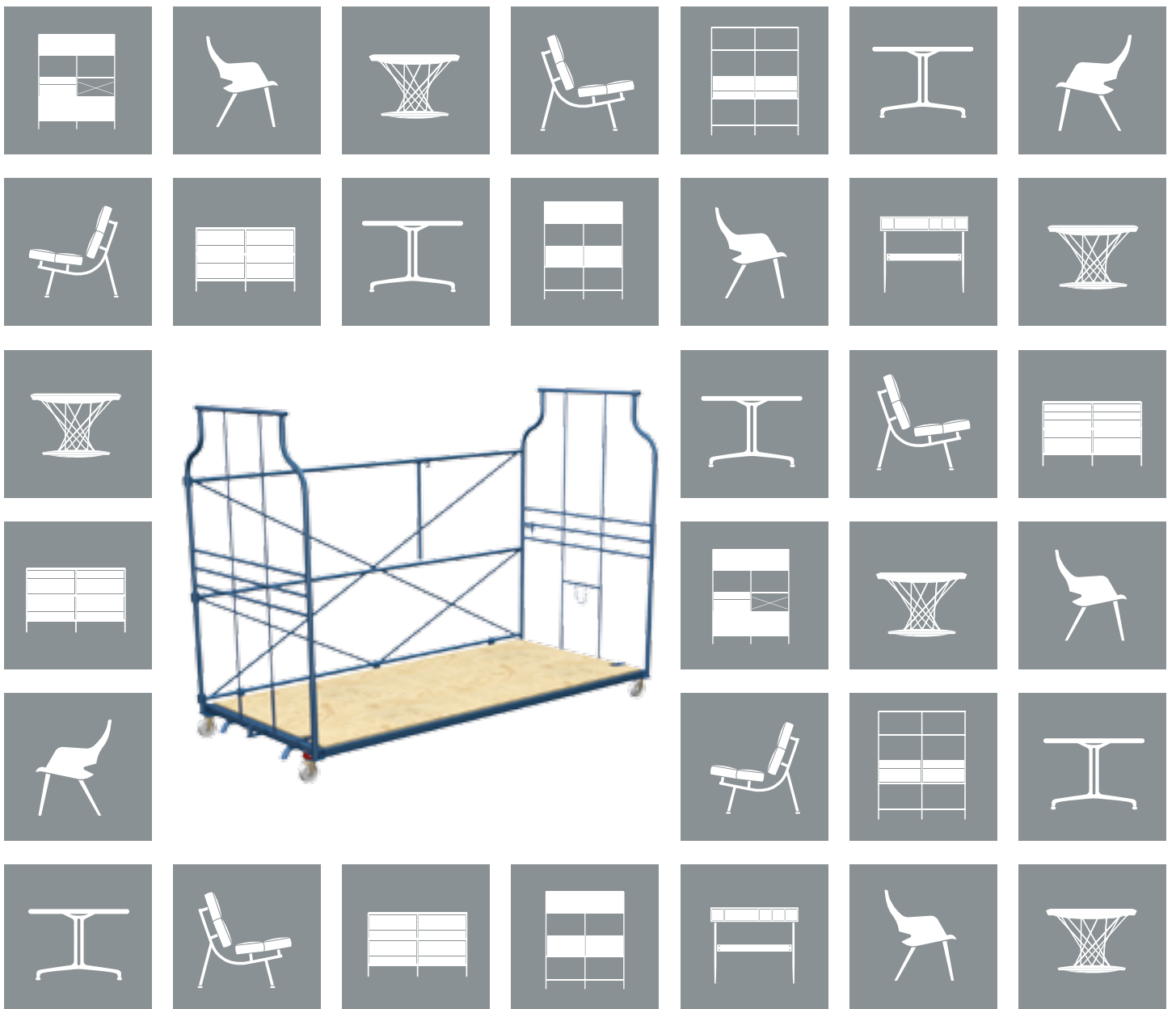

furniBOX®

The mobile solution for furniture warehouses

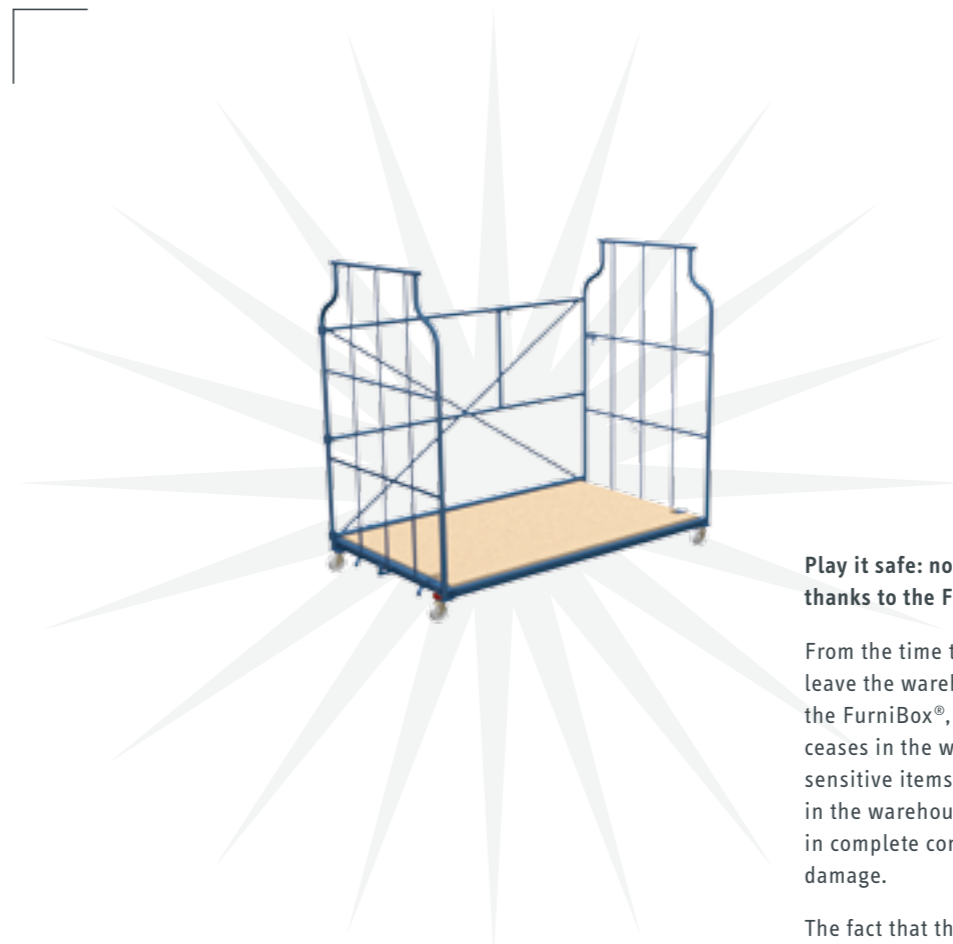



Play it safe: no more complaints - thanks to the FurniBox®

From the time the goods are received until they leave the warehouse: once it is securely placed on the FurniBox®, direct contact with your furniture ceases in the warehouse. In this way even the most sensitive items can be moved, stored and stacked in the warehouse safely and quickly and delivered in complete consignments – without any risk of damage.

The fact that the FurniBox® can additionally be folded up without any problem after use makes it even more attractive.

**Ask for our sample service.
Try out the FurniBox® for 30 days free of charge!**

p 4 → Why Cordes FurniBox®



- For upholstered furniture
- For wall cabinet units
- For bedroom furniture
- For garden furniture
- For kitchens

S 40 → FurniBox® accessories



- Folding wire mesh wall
- Elastic straps
- Additional shelves
- Shaft
- Securing devices
- Further accessories

p 14 → The FurniBox® in the warehouse



- Low-level warehouse
- Block store
- High rack store
- High-bay warehouse
- Mixed warehouse

S 42 → The Möbelhund®



- Möbelhund®
- Möbelhund® Collector

S 36 → Choose your FurniBox®



- Furniture FurniBox®
- Upholstered Furniture FurniBox®
- Universal FurniBox®
- Upholstery Element Cart
- Bedroom Box

S 46 → Introducing Cordes?



Get to know the manufacturer of the FurniBox®

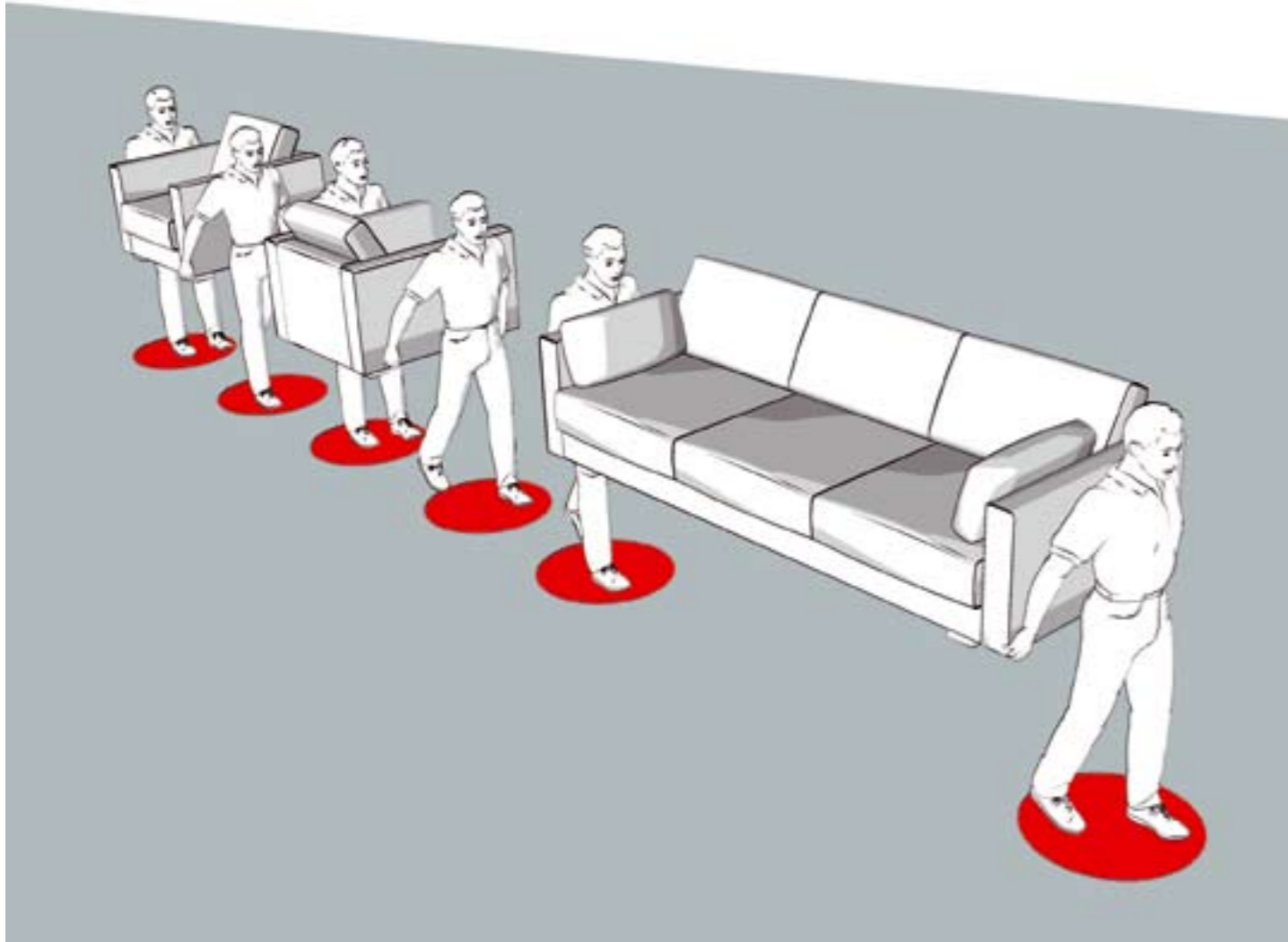

4

→ All for one?

Does everyone in your warehouse have to “lend a hand” in order to manually move a single set of furniture? Upholstered furniture is valuable and sensitive, but unfortunately also very unwieldy. This not only requires a lot of labour, but also poses the risk of damage or soiling. In short: complaints are inevitable. Have you always wanted to know how furniture transport in the warehouse can be carried out more inexpensively while making it completely safe? Then take a look to the right.



Foto © Koinor



5

→ One for all! FurniBox®



You need exactly one person to move a complete set of upholstered furniture – with the special FurniBox® for upholstered furniture. Variable bars can be adapted to any furniture size. Using the FurniBox®, you move upholstered furniture effortlessly, keeping it well protected. And, of course, we don't want to conceal the fact that the FurniBox® can even be stacked three high, thus saving a great deal of space.

Especially suitable for upholstered furniture!

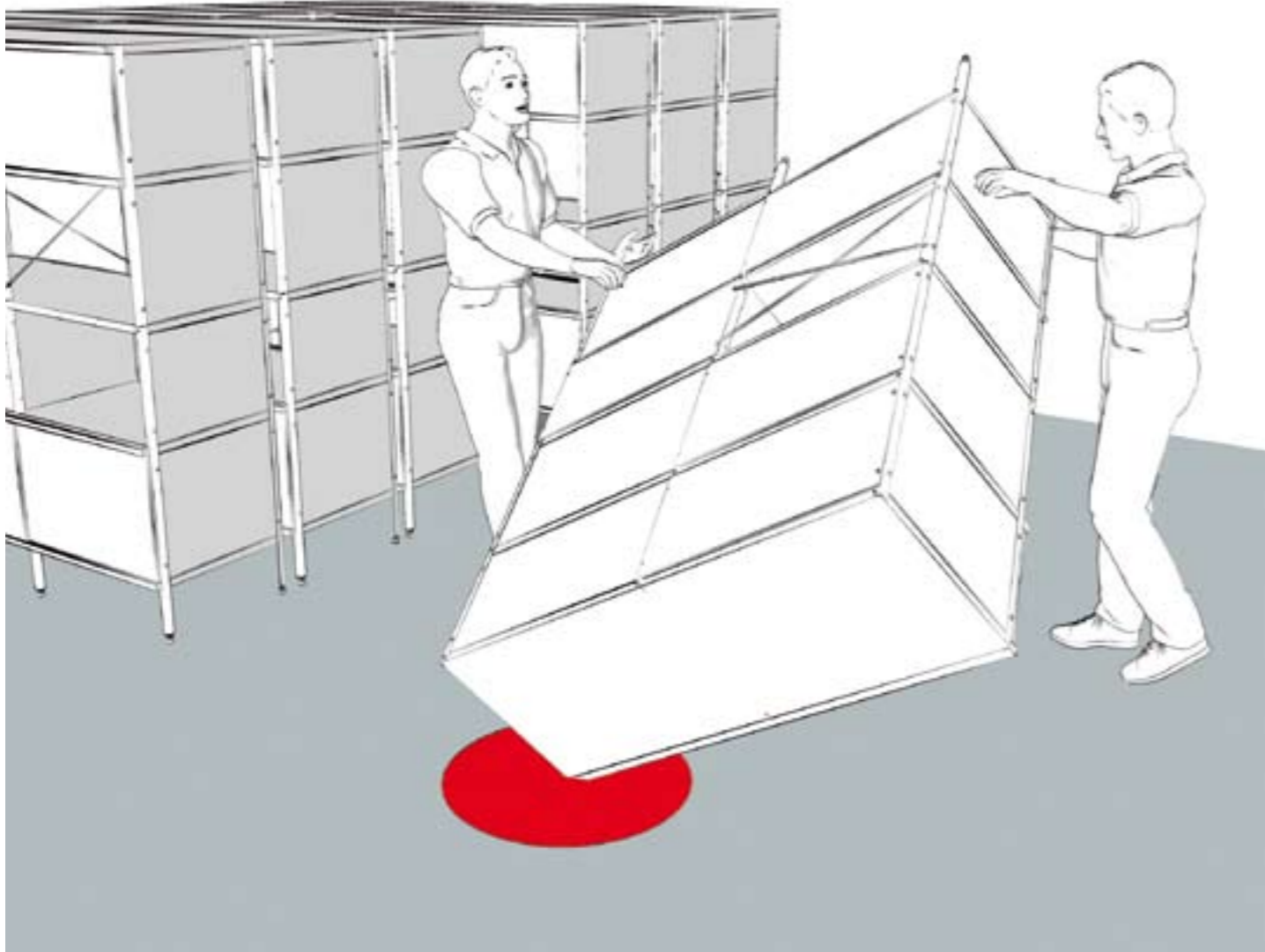

6

→ Piece chipped off?

Scratches in the elegant veneer or pieces chipped off? Does the thought of these sources of complaint make you break out in a sweat? Transporting large cabinets with sensitive surfaces is a big challenge for all warehouse staff. To make sure things run smoothly, venture a look at the FurniBox®.



Foto © Gwinner



7

→ Everything in one piece! FurniBox®



On a FurniBox® even the largest cabinet elements can be transported as safe as in a safe. Special spacers ensure that the elements are kept at a suitable distance from each other on the FurniBox®. In this way even the most sensitive cabinets stay smooth and flawless, no matter how confined the space.

Especially suitable for living-room furniture!

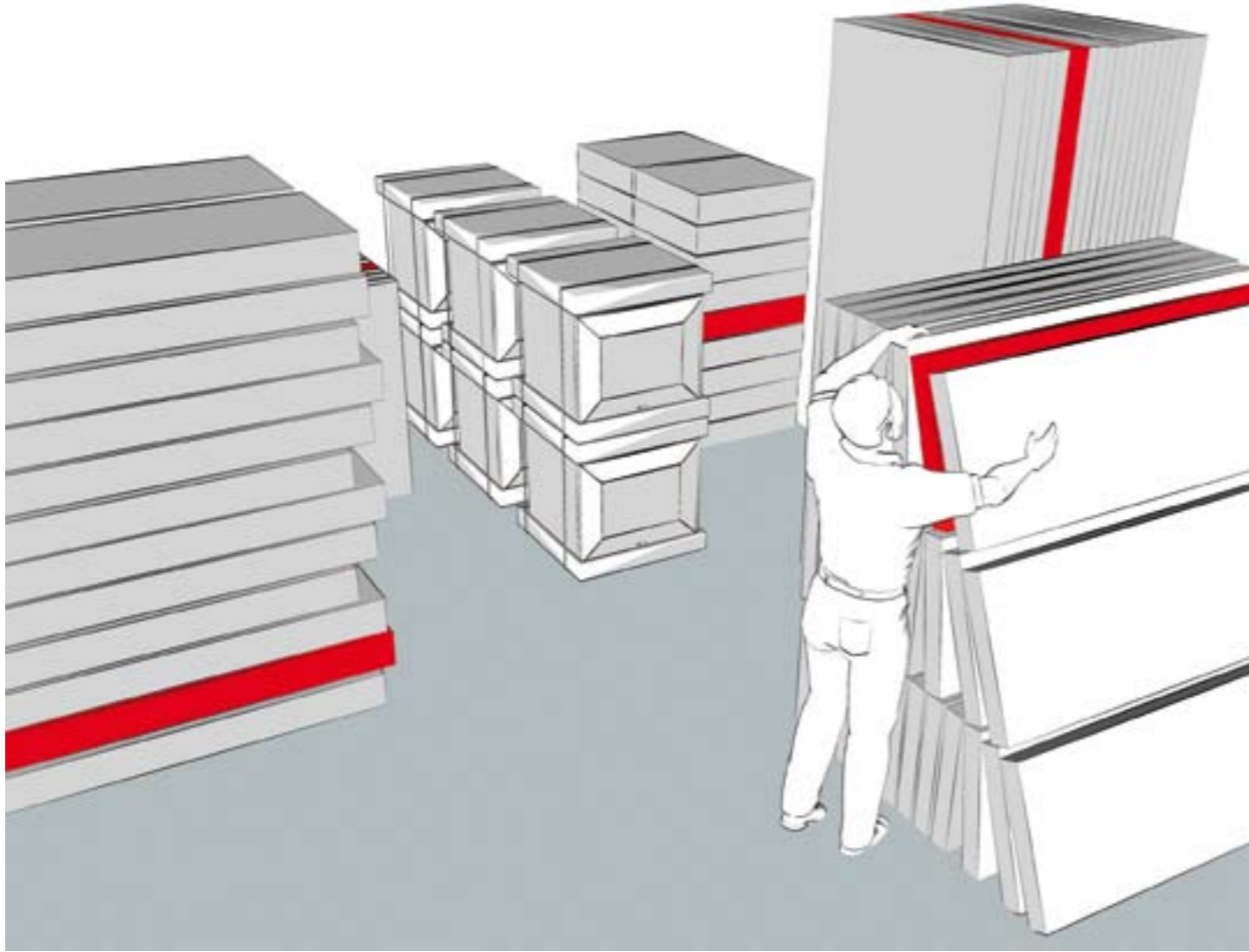

8

→ Looking for something?

When did you have the last complaint because a part was missing in the shipment of a kitchen or the refrigerator had a scratch? Complaints are expensive, and searching takes time and costs money. Would you like to know how your consignments can easily be kept together and you can store high-quality items so they are protected at the same time? Then simply read on.



Foto © Nobilia



9

→ Found it! FurniBox®

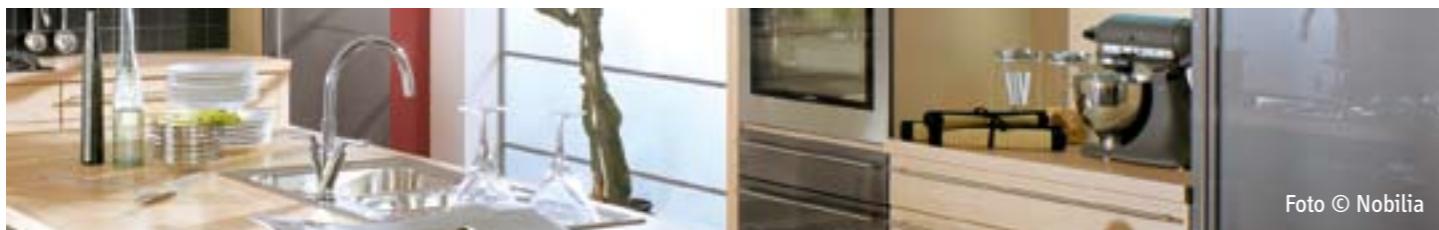

Perfect organization for order picking is no problem at all with the FurniBox®. All individual parts of a kitchen are simply put together on a FurniBox®. This not only saves space, but also the nuisance of searching. Since your sensitive kitchen furniture is optimally protected against damage by the side walls of the FurniBox®, complaints will soon cease to be an issue for you.

Especially suitable for kitchen furniture!

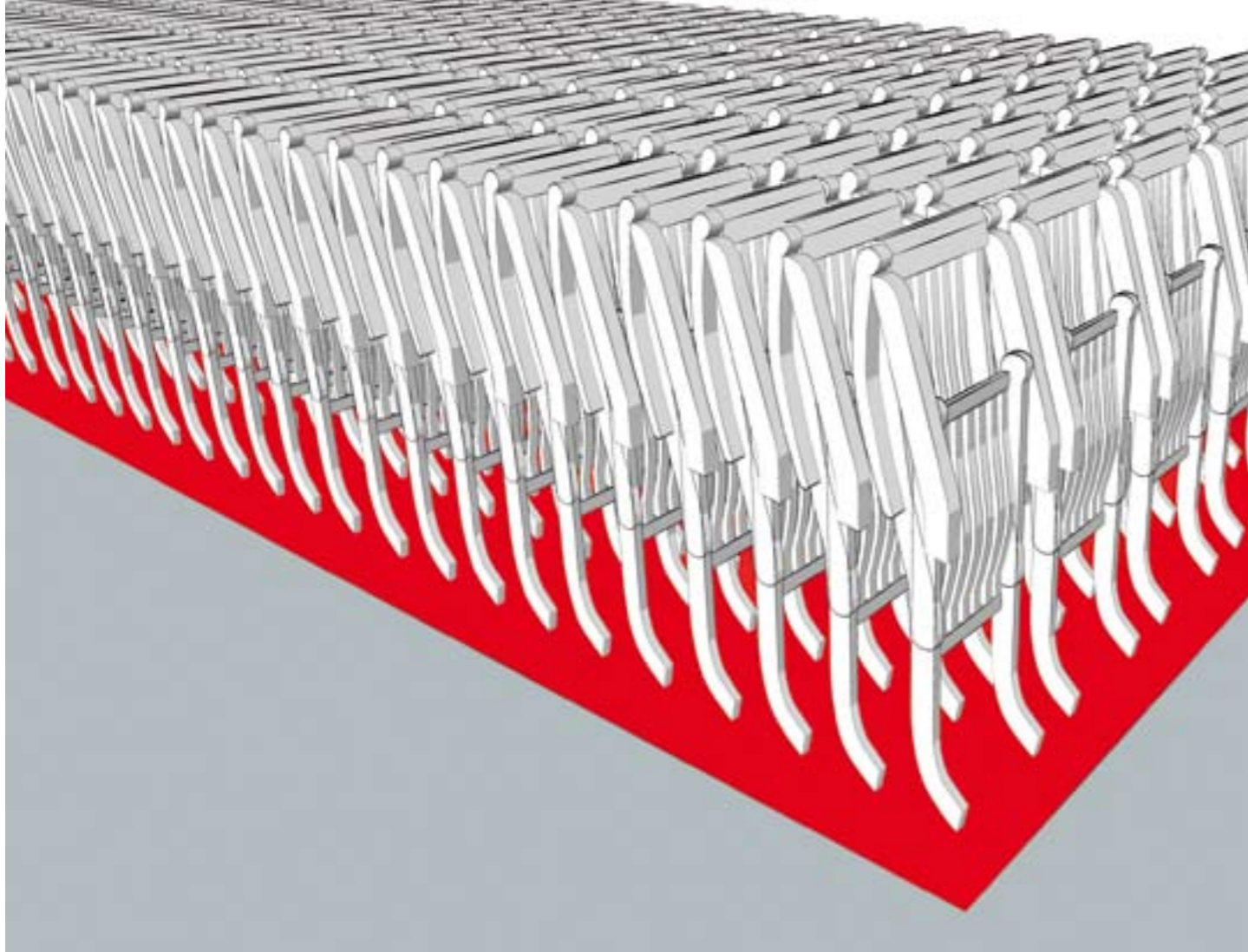

10

→ Enough room?

Does your warehouse burst at the seams at the beginning of summer because large lots of garden furniture are delivered? If warehouse areas are crammed full, transport quickly becomes a problem, especially when sales are going well and speedy delivery is important. Have you always wanted to know how seasonal goods can be stored in a space-saving fashion and transported without getting into a frenzy? Then take a look at how well this works with the FurniBox®.



Foto © Best



11

→ Plenty of room! FurniBox®



With the FurniBox® you are left with plenty of room, even when large volumes are in stock. The FurniBox® provides sufficient space for all garden furniture, which can thus be stacked on top of each other without any problem. When speed is important, you will especially appreciate the fact that the FurniBox® can be rolled, enabling you to move items quickly within the warehouse.

Especially suitable for garden furniture!

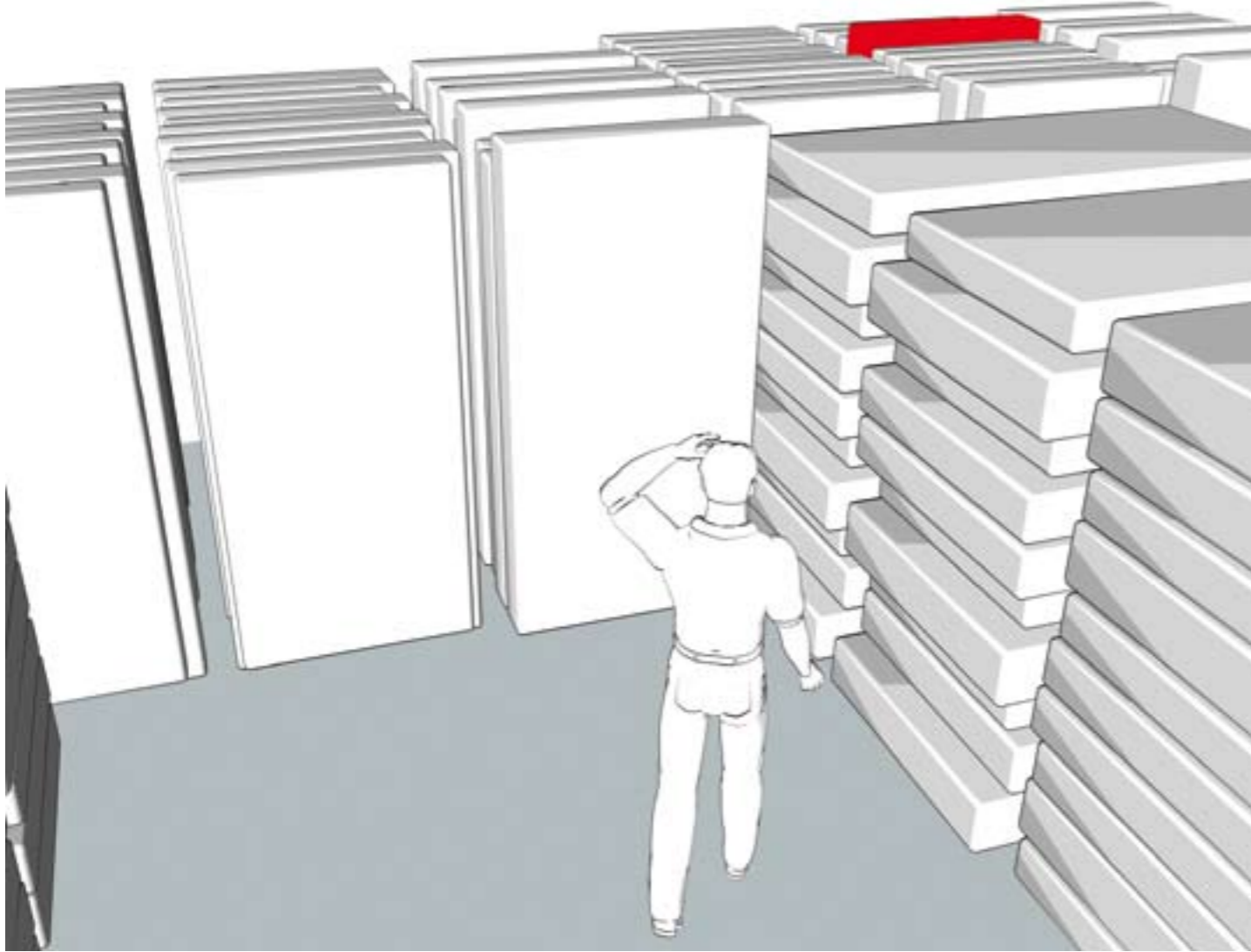

12

13

→ Stuck?

How many mattresses do you have to move to the side or restack when precisely the one all the way at the bottom or at the back is needed? No matter how many there are – there are always too many because moving the other mattresses out of the way or restacking them is laborious and time-consuming. If you have always asked yourself whether this can be done more easily, then take a look at what the FurniBox® can do for you.

→ Relax! FurniBox®



No matter how big or heavy they are – lined up neatly on a FurniBox®, even the most unwieldy mattresses can be moved in bulk without any problem. Thanks to the FurniBox®, you have quick and trouble-free access to each individual mattress or can set entire lots in motion without any effort. This means relief for your back and it saves you time.

Especially suitable for bedroom furniture!



Foto © Wackenhut

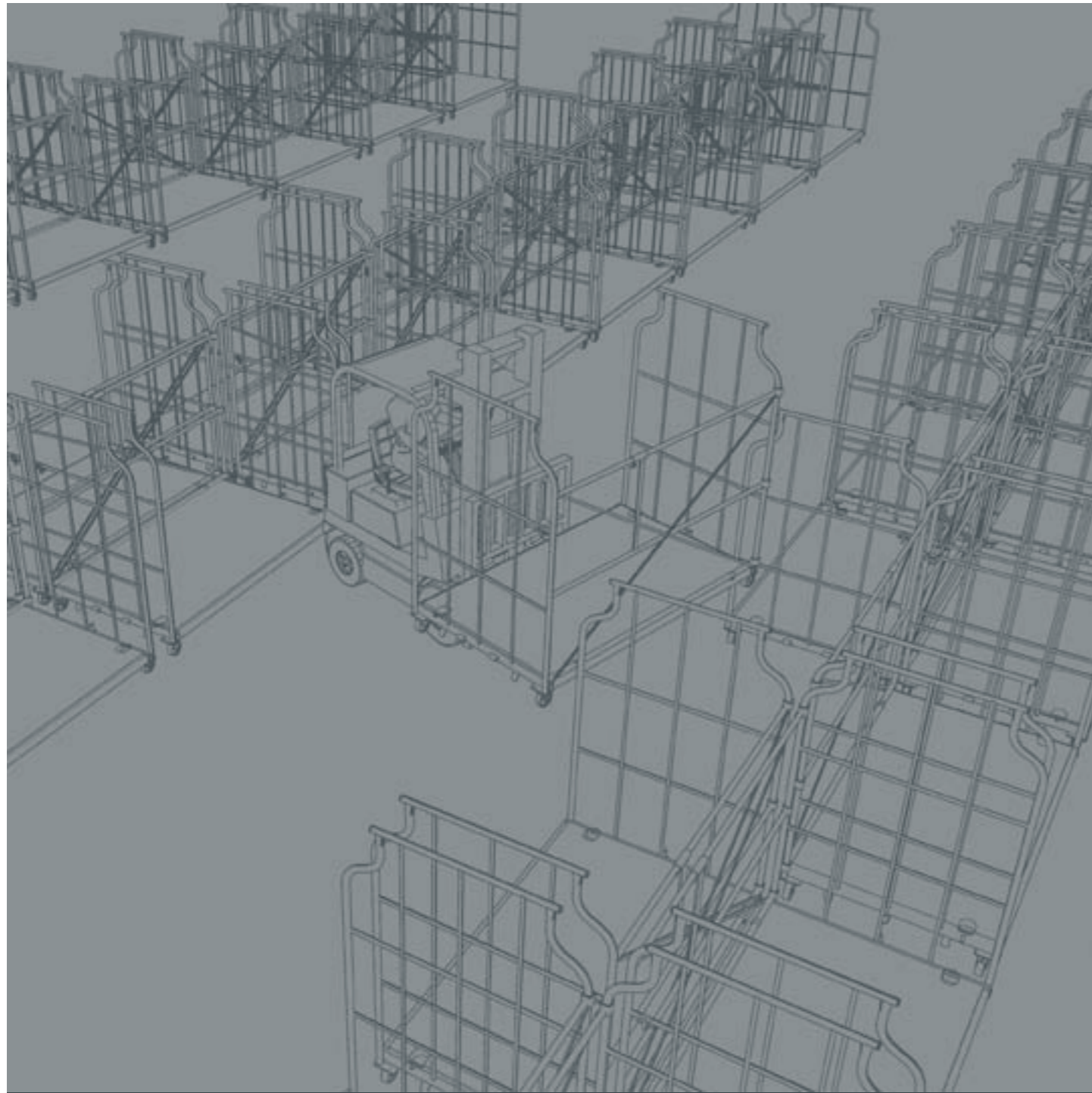

14

→ Low-level warehouse



15



Moving quickly. No more reloading. The FurniBox®.

Storing furniture in an orderly and organized fashion and still being able to access it quickly is no longer an unfulfillable dream. The FurniBox® creates space and order in low-level warehouses and additionally makes sure that things which belong together stay together. The FurniBox® can be quickly and easily moved using any standard towing vehicle.



With the FurniBox® your consignments remain complete from start to finish. Thanks its smooth-running wheels, furthermore, the FurniBox® guarantees speedy transport within your warehouse, no matter whether manually or with an electric towing vehicle. In this way you can make full use of your warehouse space and at the same time maintain quick access even to goods in the remotest corner.

The fact that the FurniBox® is available in three different sizes makes it the big favourite for every low-level warehouse



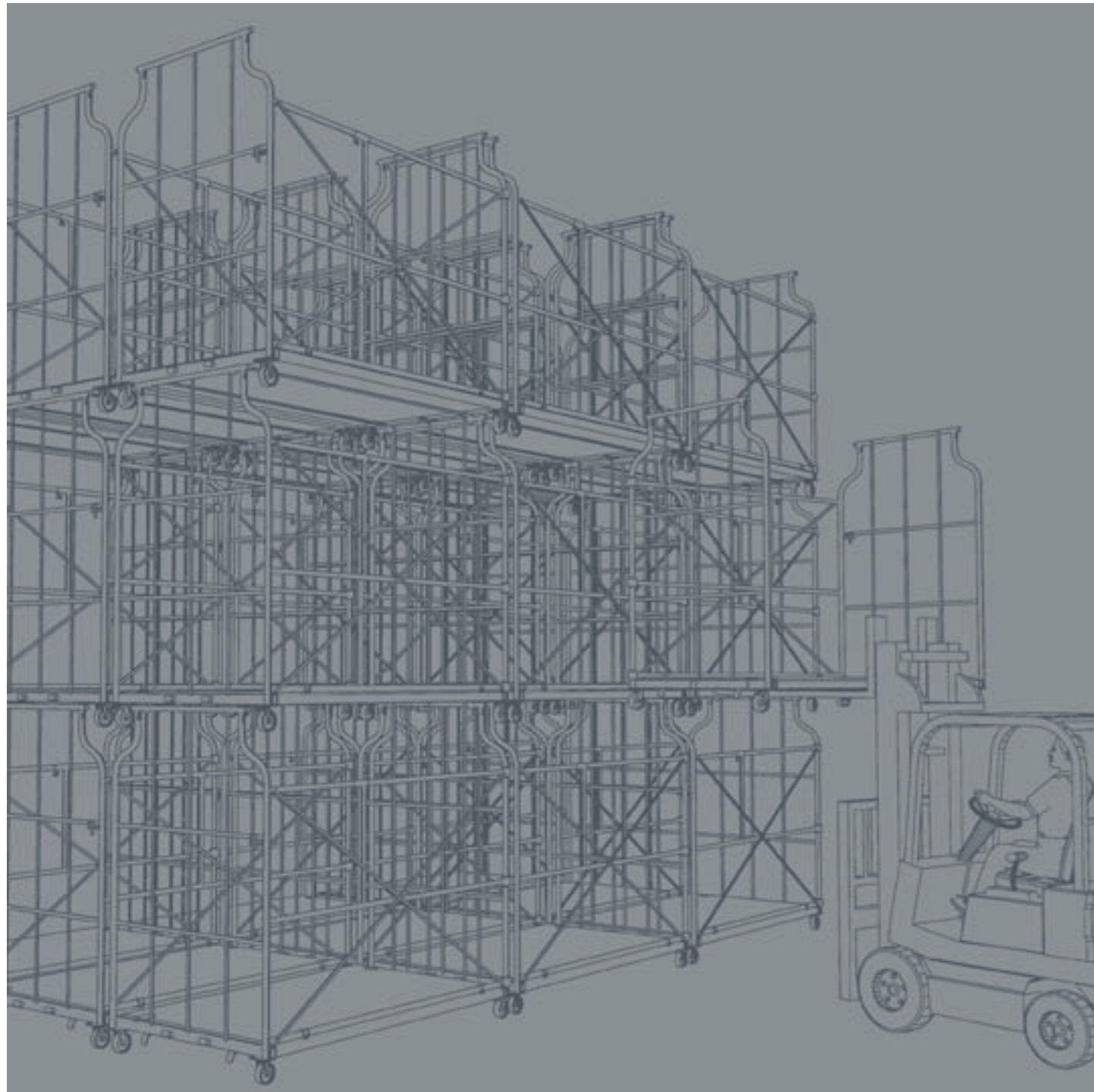

18

→ **Block store**



19



Stacking high. Gaining space. The FurniBox®.

Why is the most valuable part of your block store the air above the goods? Very simply: the FurniBox® gives you the opportunity to double or even triple your storage capacity, without having to rent a single additional square metre. This is easy and very inexpensive.

Simply stack the FurniBox® with a conventional forklift two or three high and in this way make optimal use of the height of your warehouse. And the best thing about this system is that you can do without the aisles for seasonal and mass-produced articles by using the FurniBox® and store even more goods on the same area.



The fact that the FurniBox® protects your goods against damage even at dizzy heights makes it the favourite for your warehouse manager

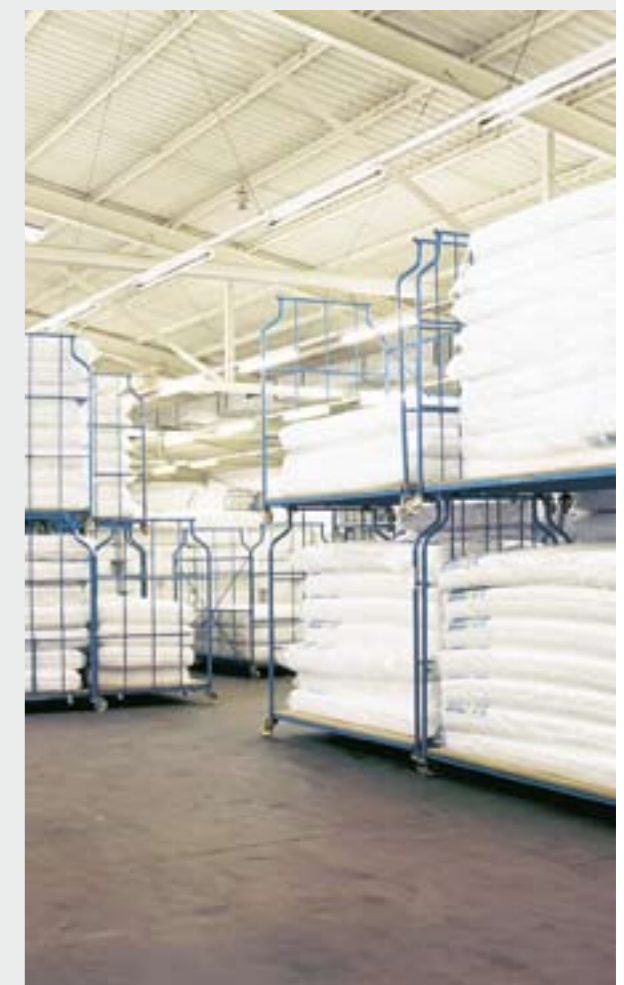

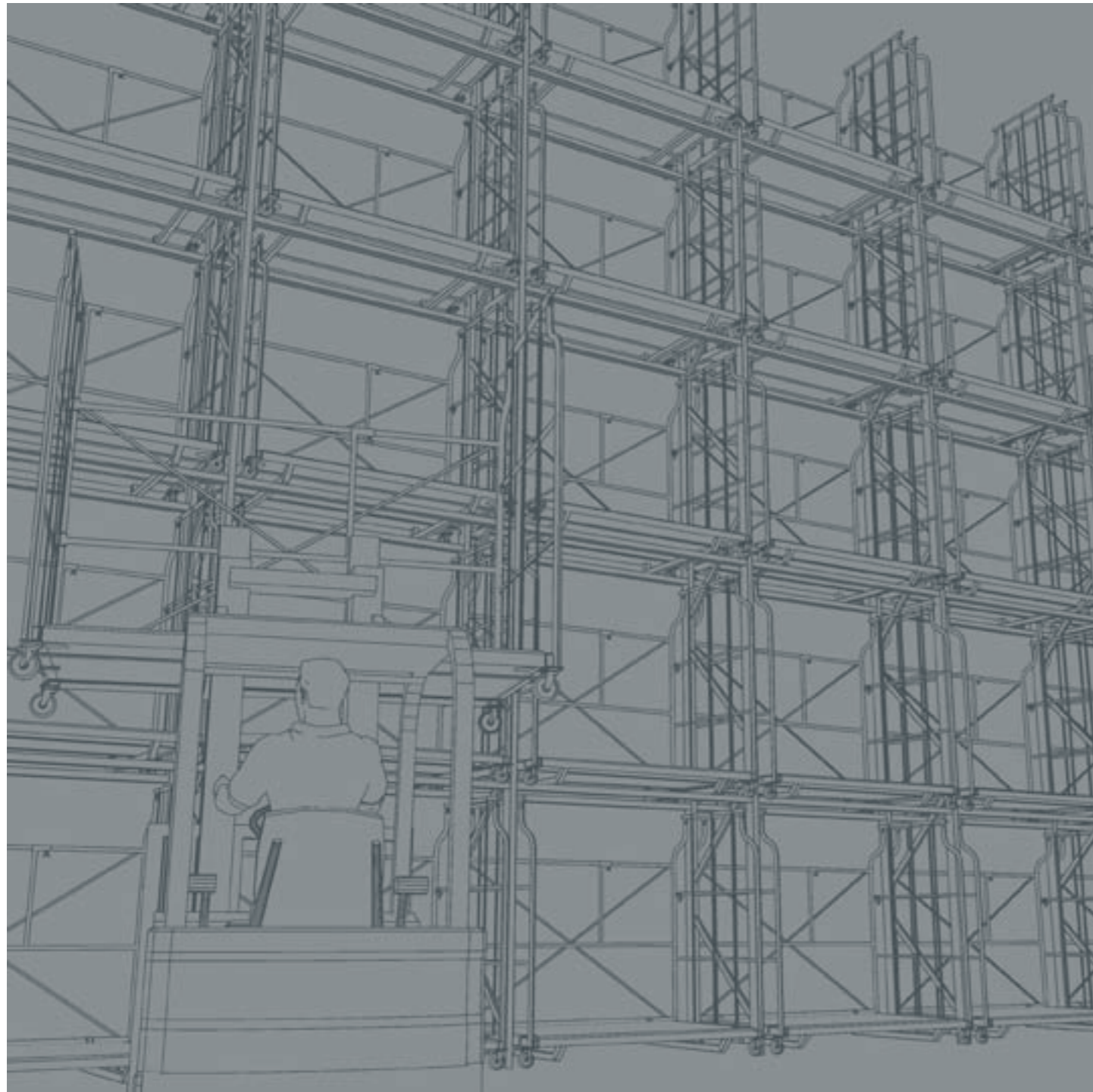

22

→ High rack store



23



The FurniBox® is particularly well suited for the use of narrow-aisle forklifts, for which an aisle width of only 1,80 m is adequate. Furthermore, by means of an order picker, you can conveniently steer for the desired rack sites with an empty FurniBox®, remove goods stored there individually and further transport them safe and sound.

In this way you make efficient use of your rack compartments to accommodate large volumes of goods and can additionally take them out of storage quickly.

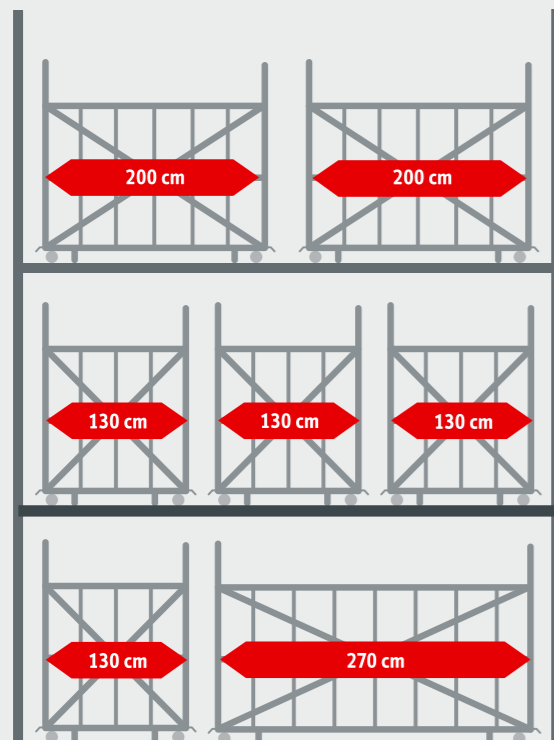

Direct access. Even at the very top. The FurniBox®

High, higher, highest! With the FurniBox® you have direct and quick access to your goods, no matter how high they are in your high rack store. An especially practical feature here is that even pieces of furniture that stick out over the top edge can be kept in a FurniBox® so that bulky items, too, can be stored well protected and available at any time.

The fact that you can combine FurniBoxes® of different sizes in your high rack store makes them the perfect all-round protection for all types of furniture



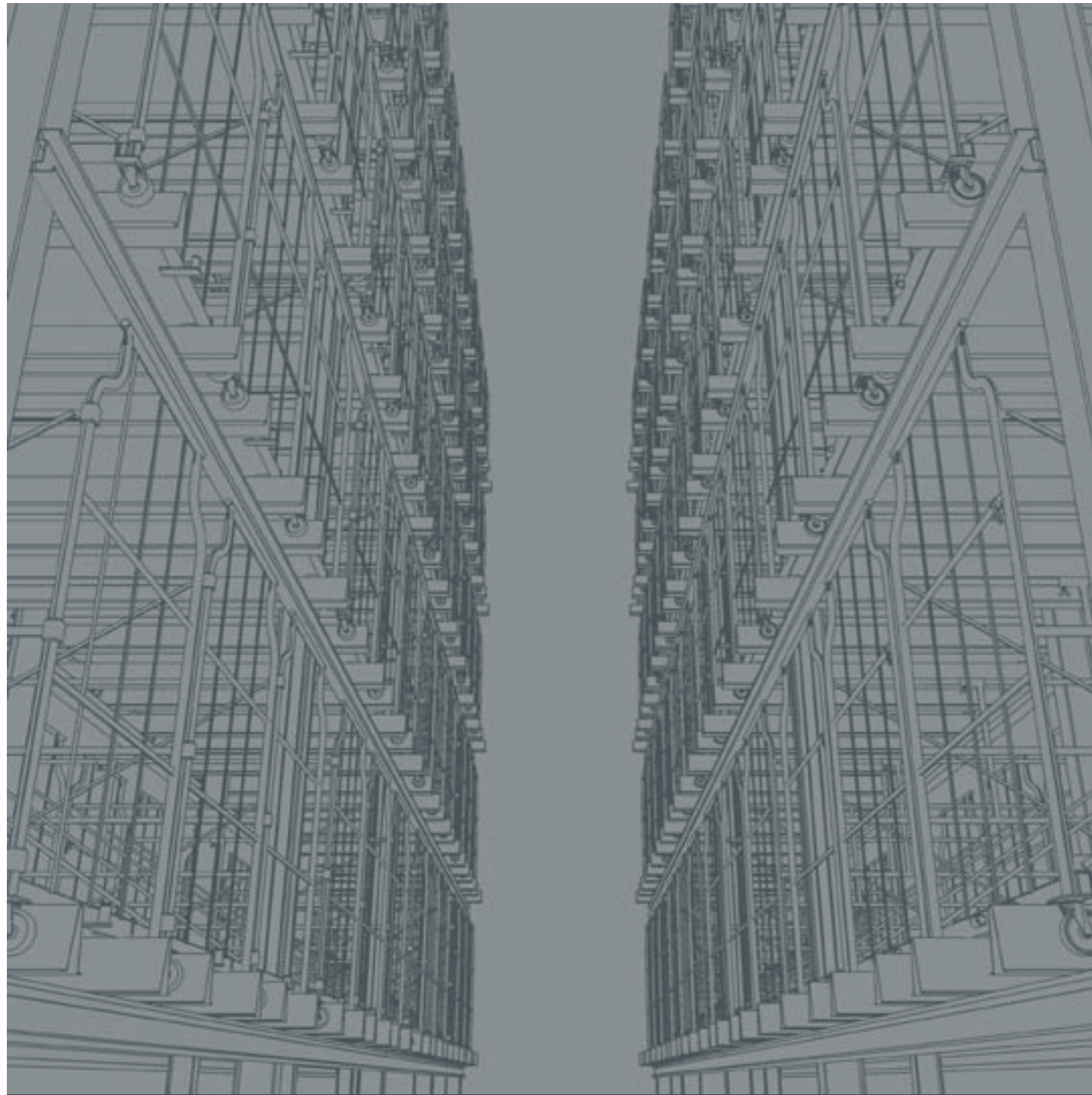

26

→ Fully automatic
high-bay warehouse

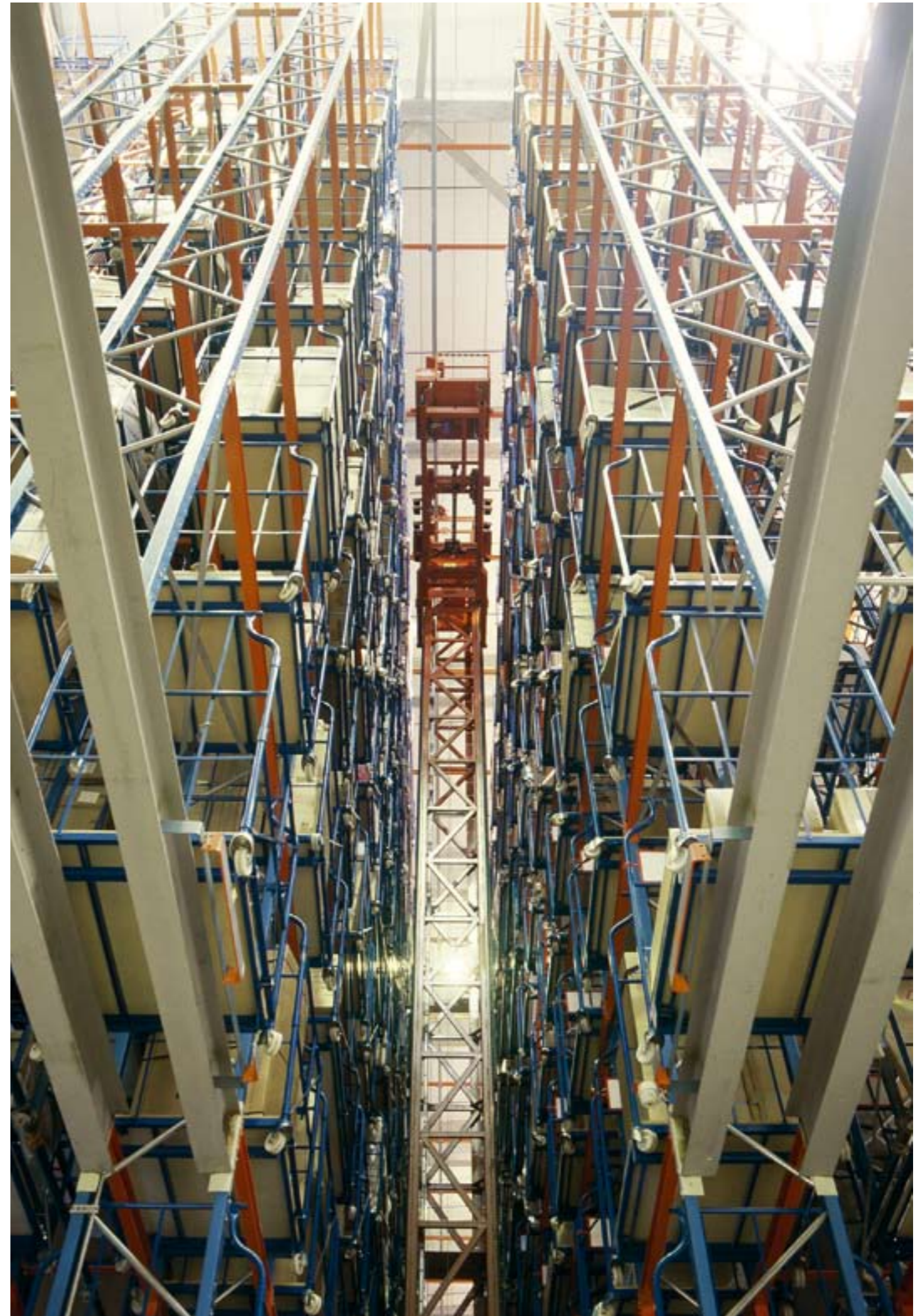

27



In operation everywhere. Always safe. The FurniBox®

No matter how rapidly your warehouse will grow in the future, the FurniBox® grows, too. Once purchased, it can be used for all types of warehouse. The FurniBox® is perfect even for state-of-the-art computer-controlled high-bay warehouses: you can carry out up to 700 operations a day for incoming and outgoing items while keeping staff assignment low if you make use of the FurniBox® concept in your high-bay warehouse.

Besides speed and efficiency, the FurniBox® offers maximum protection for your goods, even at a height of 47 m. In this way you minimize complaints, no matter how high you aim with your furniture.

The fact that automatic reloading is carried out safely, reliably and without any problem with the FurniBox® makes it a must for every furniture high-bay warehouse.



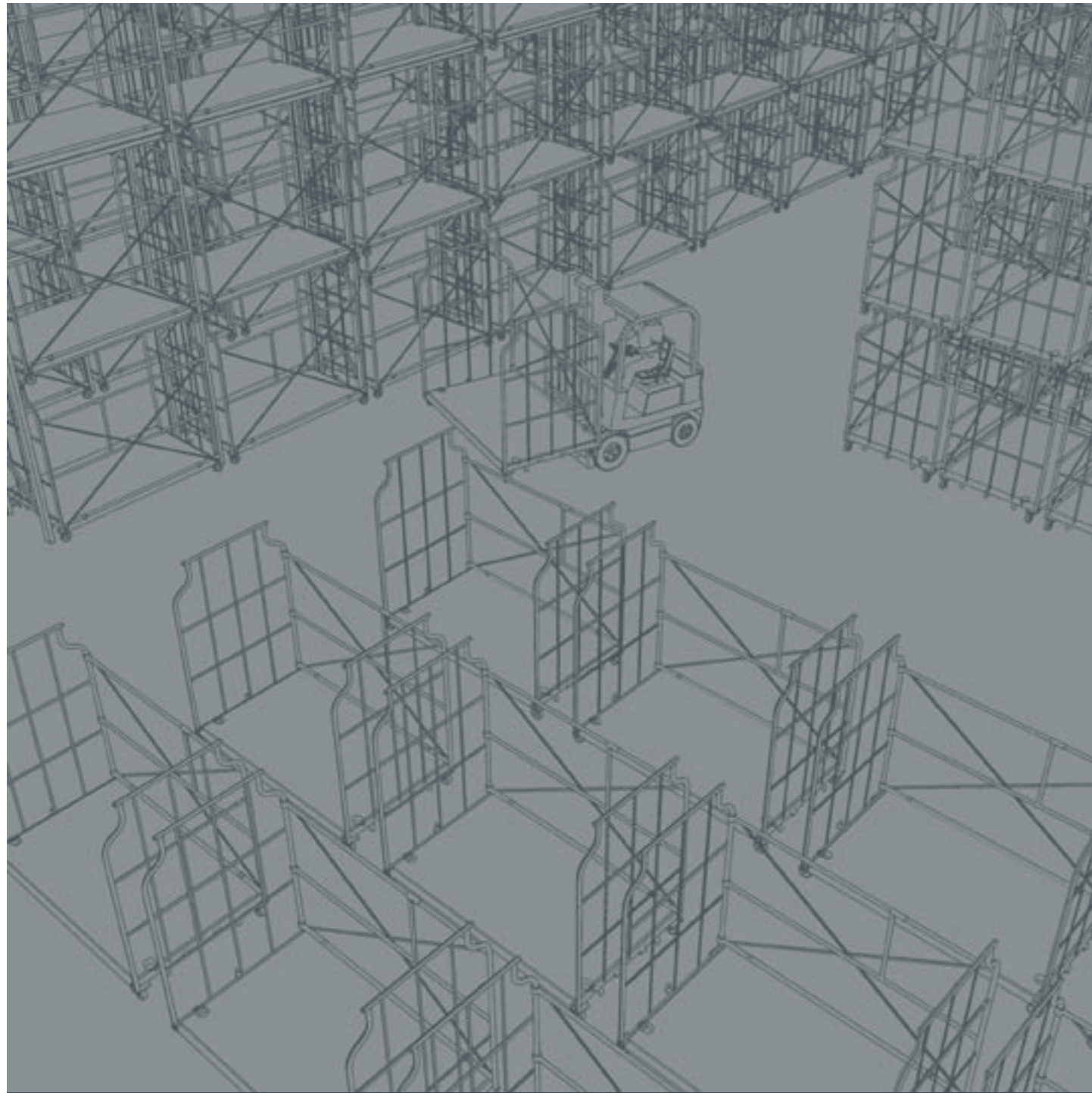

30

→ **Mixed warehouse**



31



The FurniBox® makes this work easier and safer for you. Thanks to its smooth-rolling wheels, the FurniBox® can be moved around a low-level warehouse quickly and with little effort. A single member of the staff can manually move the FurniBox® with a load of up to 1000 kg with ease. Stacked on top of one another, it offers enormous reserve space for busy, high-volume periods and on the rack it ensures quick access to the goods at any time.

The fact that the FurniBox® protects your goods as if they were in a safe, even in hectic situations, will delight your complaints department all the more.

Roll fast. Stack high. Anything is possible. The FurniBox®

How often do you have to adapt the warehousing situation in your combination store flexibly to shifts in product lines and seasonal fluctuations? Large consignments come in, others must be moved out of the way or stored for a longer period for sale in the next season. These are situations, therefore, in which a great deal of labour is required to move the goods around and the risk of damage is high.



→ Flexible



Loading and unloading in 5 minutes? No problem with the FurniBox®

It couldn't be any faster and easier. Without any need of reloading, your goods roll out of your warehouse on the Universal FurniBox® directly into the truck and thus optimally protected to the customer. In this way Universal FurniBox® guarantees rapid loading of trucks and safe shipment. By virtue of dimensions that are precisely geared to truck transport, the Universal FurniBoxes® can be positioned exactly next to each other on the truck floor and secure each other in this way.



Heavy loads, uneven surfaces? No problem with the FurniBox®

You can effortlessly transport loads of up to 800 kg with the Universal FurniBox®, even on uneven surfaces. The stable frame structure of the Universal FurniBox® and the high quality of its wheels make this possible. And so you can depend on your goods remaining undamaged when things get turbulent again, the UniversalFurniBox® is additionally equipped with solid impact protection.



Staying on course with different types of furniture? No problem with the FurniBox®

Any desired numbers of FurniBoxes® can be towed together as a unit with an electric truck. In this way you can move large lots of diverse items quickly and in an organized fashion both in your low-level warehouse and outdoors.



A rack where there isn't one? No problem with the FurniBox®.

Even the smallest hut has space – this is the motto of those who put their trust in the FurniBox®. Stacked on top of one another, the FurniBox® makes use of the full height of your warehouse, even without installation of a rack system, whenever you wish.

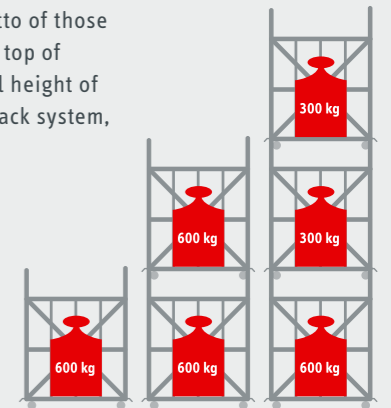

A transport container that "slims down" after use? No problem with the FurniBox®

Does it bother you when transport containers just get in the way and block valuable space in the warehouse or truck until their next use? Then you should take a closer look at the FurniBox®. The FurniBox® can be folded up in no time and therefore takes up minimal space when empty. This saves room in the warehouse and freight costs for transport.



→ FurniBox®



FurniBox® 1300			
Ext. dimensions	W: 1300 mm	D: 1150 mm	H: 1800 mm
Int. dimensions	W: 1200 mm	D: 1100 mm	H: 1610 mm
Weight: 67 kg	Load cap.: 600 kg	Top load: 600 kg	stackable 3-high
Loading height: 200 mm, underclearance: 143 mm, mesh size on sides: 530 x 260 mm, horizontal tubular piece in side wall: 1010 mm.			Order No. mc-130.001

FurniBox® 2000			
Ext. dimensions	W: 2000 mm	D: 1150 mm	H: 1800 mm
Int. dimensions	W: 1900 mm	D: 1100 mm	H: 1610 mm
Weight: 82 kg	Load cap.: 600 kg	Top load: 600 kg	stackable 3-high
Loading height: 200 mm, underclearance: 143 mm, mesh size on sides: 530 x 260 mm, horizontal tubular piece in side wall: 1010 mm.			Order No. mc-130.001

FurniBoxes® are the tailored solution for the furniture industry. Optimally suited for low-level warehouses and block stores and with additional equipment also for high-bay warehouses. Sturdy tubular steel frame construction. 1 inch = 34 mm thick. High-quality synthetic paint, blue RAL 5012, set of wheels: 100 mm polypropylene, 3 swivel castors and 1 directional roller. Expandable thanks to special accessories.

→ Universal FurniBox®



Universal FurniBox® 1200			
Ext. dimensions	W: 1200 mm	D: 1150 mm	H: 1850 mm
Int. dimensions	W: 1120 mm	D: 1100 mm	H: 1600 mm
Weight: 90 kg	Load cap.: 800 kg	Top load: 1000 kg	stackable 3-high
Loading height: 240 mm, underclearance: 170 mm, mesh size: 500 x 260 mm, 1st horizontal tubular piece in side wall: 480 mm, 2nd horizontal tubular piece in side wall: 990 mm.			Order No. uc-120.500

Universal FurniBox® 2000			
Ext. dimensions	W: 2000 mm	D: 1150 mm	H: 1850 mm
Int. dimensions	W: 1920 mm	D: 1100 mm	H: 1600 mm
Weight: 110 kg	Load cap.: 800 kg	Top load: 1000 kg	stackable 3-high
Loading height: 240 mm, underclearance: 170 mm, mesh size: 500 x 260 mm, 1st horizontal tubular piece in side wall: 480 mm, 2nd horizontal tubular piece in side wall: 990 mm.			Order No. uc-200.500

The perfect solution for in-house handling of goods as well as shipment via truck: rugged impact protection in base frame of 80 x 50 mm U-steel. Universal FurniBoxes® fit on a truck next to each other 2-deep and secure each other in this way. Set of wheels: 125 mm polyamide, 3 swivel castors and 1 directional roller. Sturdy tubular steel frame 1 inch = 34 mm thick. High-quality synthetic paint, blue RAL 5012. "Snap-o-matic": automatic locking of bottom and quick opening with single-hand release.

36



FurniBox® 2500			
Ext. dimensions	W: 2500 mm	D: 1150 mm	H: 1800 mm
Int. dimensions	W: 2370 mm	D: 1100 mm	H: 1610 mm
Weight: 82 kg	Load cap.: 600 kg	Top load: 600 kg	stackable 3-high
Loading height: 200 mm, underclearance: 143 mm, mesh size on sides: 530 x 260 mm, 2 tubular pieces in side wall: 710 mm and 910 mm.			Order No. mc-250.001

FurniBox® 2700			
Ext. dimensions	W: 2000 mm	D: 1150 mm	H: 1800 mm
Int. dimensions	W: 1900 mm	D: 1100 mm	H: 1610 mm
Weight: 82 kg	Load cap.: 600 kg	Top load: 600 kg	stackable 3-high
Loading height: 200 mm, underclearance: 143 mm, mesh size on sides: 530 x 260 mm, 2 tubular pieces in side wall: 710 mm and 910 mm.			Order No. mc-270.001

37

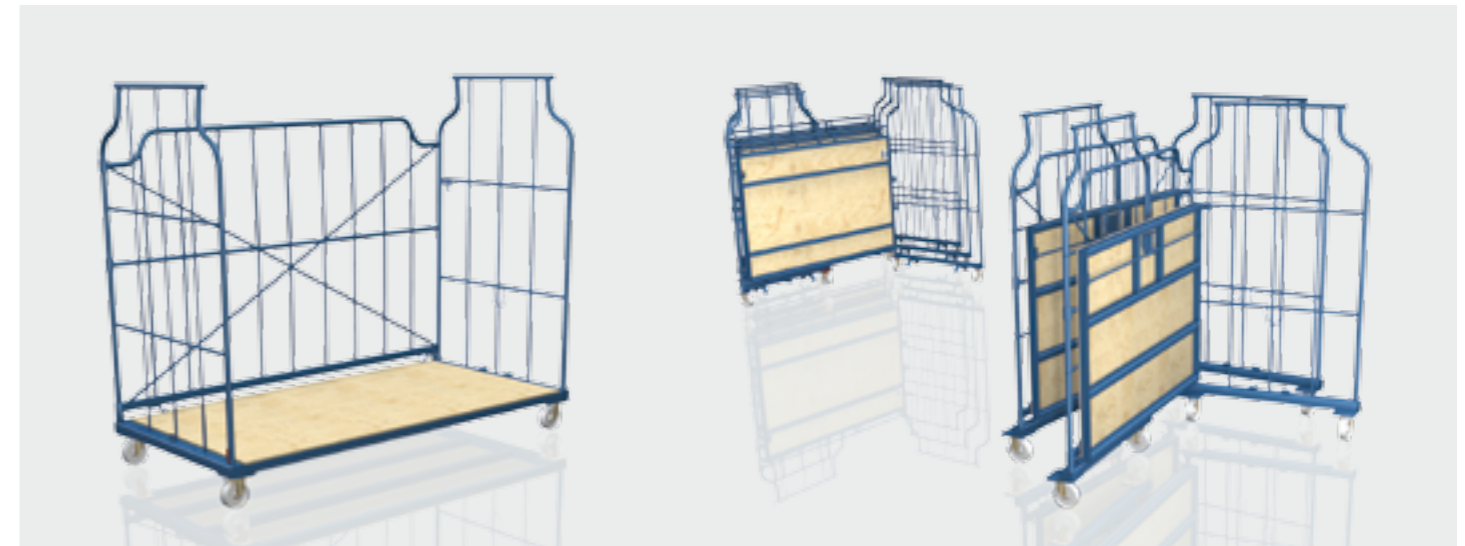

Universal FurniBox® 2400			
Ext. dimensions	W: 2400 mm	D: 1150 mm	H: 1850 mm
Int. dimensions	W: 1320 mm	D: 1100 mm	H: 1600 mm
Weight: 125 kg	Load cap.: 800 kg	Top load: 1000 kg	stackable 3-high
Loading height: 240 mm, underclearance: 170 mm, mesh size: 500 x 260 mm, 1st horizontal tubular piece in side wall: 480 mm, 2nd horizontal tubular piece in side wall: 990 mm.			Order No. uc-240.500

All FurniBoxes® can be folded up by means of the "fold-up trick" (p. 35). Space when folded-up: 75%.

Try it out for 30 days free of charge!
SAMPLE SERVICE
 Give us a call.

→ FurniBox® for upholstery



FurniBox® 2500 for upholstery			
Ext. dimensions	W: 2500 mm	D: 1150 mm	H: 2350 mm
Int. dimensions	W: 2450 mm	D: 1100 mm	H: 2150 mm
Weight: 67 kg	Load cap.: 600 kg	Top load: 600 kg	stackable 3-high
Loading height: 200 mm, underclearance: 134 mm, mesh size on sides: 530 x 260 mm, three horizontal tubular piece in side wall: 970 mm, 1070mm and 1170mm.			Order No. mc-250.620

FurniBox® 2700 for upholstery			
Ext. dimensions	W: 2700 mm	D: 1150 mm	H: 2350 mm
Int. dimensions	W: 2615 mm	D: 1100 mm	H: 2150 mm
Weight: 109 kg	Load cap.: 600 kg	Top load: 600 kg	stackable 3-high
Loading height: 200 mm, underclearance: 134 mm, mesh size on sides: 530 x 260 mm, three horizontal tubular piece in side wall: 970 mm, 1070mm and 1170mm.			Order No. mc-270.620

The FurniBox® for upholstery has been specially developed for upholstered furniture. Optimal protection against damage, optimal utilization of space in the warehouse. Suitable for all types warehouse thanks to extras. Sturdy tubular steel frame construction. 1 inch = 34 mm thick. High-quality synthetic paint, blue RAL 5012, set of wheels: 100 mm polypropylene, 3 swivel castors and 1 directional roller.

→ Bedroom Box



Bedroom Box			
Ext. dimensions	W: 1730 mm	D: 730 mm	H: 1730 mm
Int. dimensions	W: 1650 mm	D: 860 mm	H: 1540 mm
Weight: 99 kg	Load capacity: 600 kg		
Loading height: 190 mm, underclearance: 134 mm, space savings when folded up: 75%, set of wheels: 100 mm polypropylene, 3 swivel castors and 1 directional roller.			Order No. sb-920.008

When empty, the Bedroom Box can be folded up. This results in space savings of 70%. A stopper prevents the bottom from folding back. In this way the Bedroom Box can be stored ready for use again in the warehouse.

→ Upholstery Element Cart



Upholstery Set Cart			
Ext. dimensions	W: 2800 mm	D: 1100 mm	H: 1260 mm
Int. dimensions	W: 2200 mm	D: 700 mm	H: 920 mm
Weight: 25 kg	Load capacity: 300 kg		
Loading height: 280 mm, space savings when folded up: 80%, set of wheels: 100 mm rubber wheels no-trace, intermediate level height: 920 mm.			Order No. pg-913.000

Upholstery Element Cart, 2 levels			
Ext. dimensions	W: 2800 mm	D: 1100 mm	H: 1260 mm
Int. dimensions	W: 2200 mm	D: 700 mm	H: 920 mm
Weight: 35 kg	Load capacity: 300 kg		
Loading height: 320 mm, space savings when folded up: 80%, set of wheels: 100 mm rubber wheels no-trace, intermediate level height: 920 mm.			Order No. pe-911.000

The Upholstery Set Cart moves upholstered furniture elegantly and with ease to any place desired. In spite of its light weight, it is made of rugged tubular steel and specially geared to upholstered furniture. High-quality synthetic paint, blue RAL 5012, set of wheels: 100 mm polypropylene, 3 swivel castors and 1 directional roller. The pull-out bars are galvanized and can be extracted to an variable length from 2200 to 2800 mm and even up to 3100 mm (3 level Cart). They can thus be adapted to the specific upholstered furniture load.



Upholstery Element Cart, 3 levels			
Ext. dimensions	W: 3100 mm	D: 1100 mm	H: 1850 mm
Int. dimensions	W: 2400 mm	D: 860 mm	H: 1850 mm
Weight: 65 kg	Load capacity: 300 kg		
Loading height: 320 mm, space savings when folded up: 80%, set of wheels: 100 mm rubber wheels no-trace, intermediate level height: 730 mm.			Order No. pe-915.000

The Upholstery Set and Element Carts can be folded up when empty to save space. The bar supports are galvanized and can be pulled out to an infinitely variable length so as to adapt the support surface to the specific upholstered furniture.

Try it out for 30 days free of charge!
SAMPLE SERVICE
Give us a call.

→ Accessories

The numerous well thought-out accessories, which Cordes has developed specially for the FurniBox®, make the FurniBox® even more efficient and the organization of your warehouse child's play.



Side wall wire mesh
The mesh size can be reduced by means of narrower wire mesh or additional flat bars. Detachable front door to secure the load, can be folded down halfway.

Product	Order No.
Door 1200	zuc-120.599
Door 2000	zuc-200.599
Door 2400	zuc-240.599
Wire mesh	on request

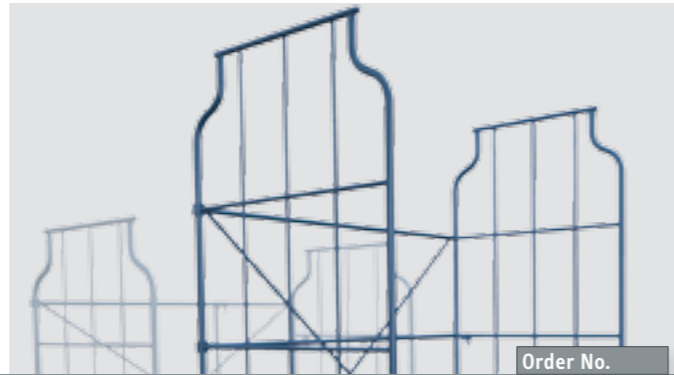

Special size
To protect bulky or long pieces of furniture that have a secure place in the Corlette. Special sizes are described in detail on page 49.

Order No.
on request

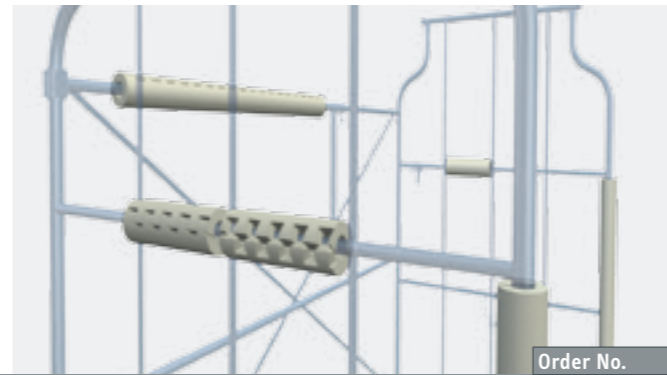

Protective aids of foamed material
Easy to mount, easy to replace wherever additional protection is required.

Order No.
on request

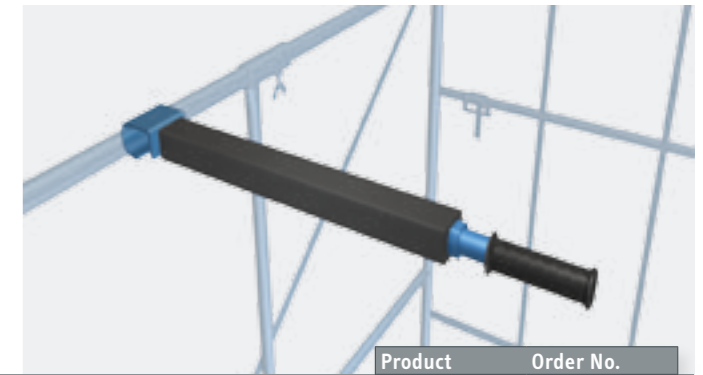

Retention arm with foamed material
Advantageous in many ways: operated with one hand, optimal protection for the goods, can be used on both sides and also be mounted subsequently.

Product	Order No.
1 inch tube	zca-000.135
3/4 inch tube	zca-000.535

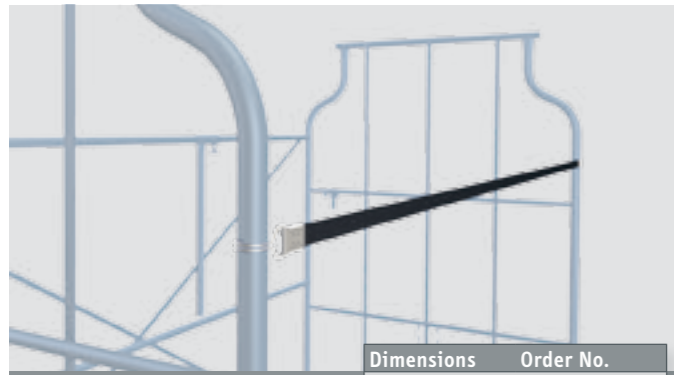

Elastic strap
For safeguarding the goods flexibly but extremely securely, also with partial loads, at any place within the FurniBox®. Tearproof, UV-resistant, looped on one side, other side with hook.

Dimensions	Order No.
1200 / 1300	zca-130.003
1800 / 2000	zca-200.003
2400 / 2700	zca-240.003

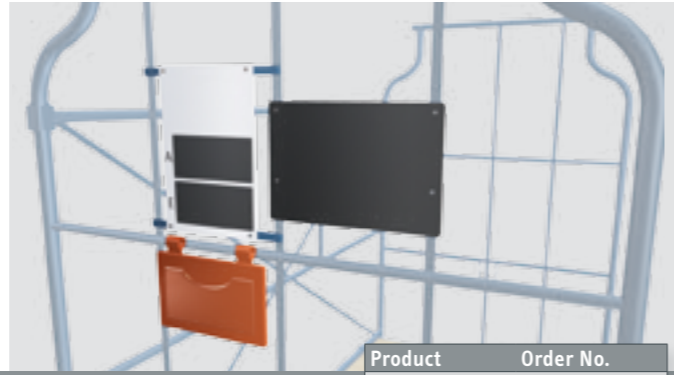

Labelling elements
Blackboard: aluminium blackboard with school blackboard coating
SHD sign: accessory for warehouse organization software from SHD
Pocket: for safekeeping of accompanying documents

Product	Order No.
Alu blackboard	zca-000.007
SHD sign	kmc-000.000
Pocket	zca-000.013



Shelf skids
Necessary accessory for stacking on FurniBox® shelf.

Order No.
on request

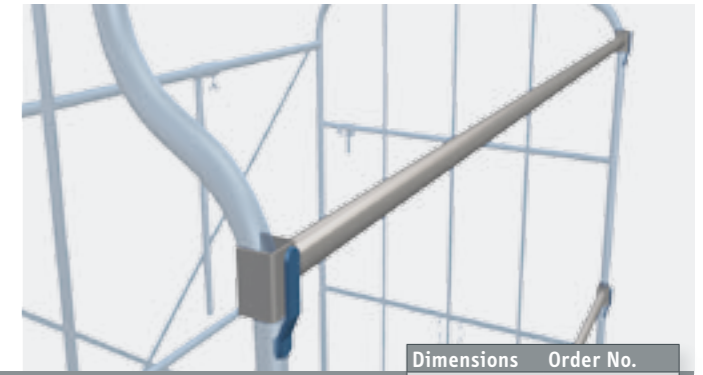

Supporting / load-securing elements
Applicable as a support in several elements and/or as a load-securing aid mounted in side wall, painted or galvanized.

Dimensions	Order No.
1200 mm	zca-120.001
1300 mm	zca-130.001
2000 mm	zca-200.001
2400 mm	zca-240.001
2500 mm	zca-250.001
2700 mm	zca-270.001



Shaft
For attachment to tractors of any kind and for towing several FurniBox®s in a group.

Product	Order No.
Shaft	zca-000.007



PVC protective clip
Perfect protection for long items leaned against sides

Product	Order No.
PVC clip	kca-000.005



Shelf
Can be inserted as an intermediate shelf at one or more levels.

Dimensions	Order No.
1200 mm	zca-120.000
1300 mm	zca-130.000
2000 mm	zca-200.000
2400 mm	zca-240.000
2500 mm	zca-250.000

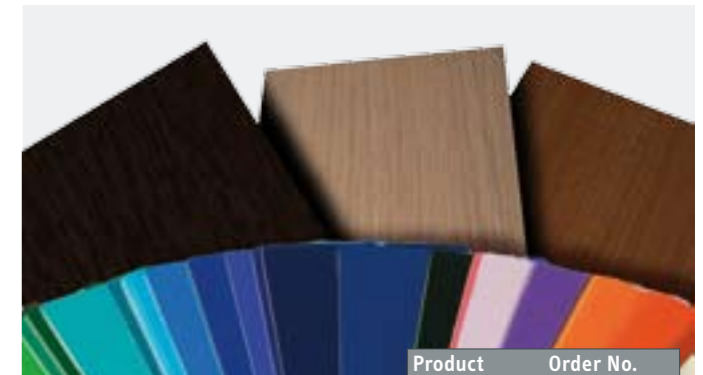

Types of wood for shelves and bottom / FurniBox® paint
Plywood 6-21 mm thick, available unfinished, weatherproof or film-coated. Painting in any desired colour is possible.

Product	Order No.
Wood	on request
Paint	on request



Our proven furniture assistant: The Cordes Möbelhund®.

In most cases the simplest inventions are the most ingenious. Our Möbelhund® is also ingeniously simple and tried and tested a million times over. Wherever a heavy or unwieldy piece of furniture has to be moved, the Möbelhund® is an irreplaceable assistant. Its sturdy beechwood bottom carries the heaviest of loads even many years after its purchase. Its smooth-running wheels enable effortless transport on all surfaces. The standard "no-trace" rubber wheels roll even on light-coloured carpeting without any black marks!

To ensure that your furniture does not start slipping even on uneven surfaces, the Möbelhund® is provided with an antiskid coating. Rubber buffers on all sides additionally act as impact protection for walls and doors. In this way the Möbelhund is perfectly equipped to avoid complaints and damage right from the start.

The Möbelhund® Europa is the noblest! Equipped with a special rubber hood, the Möbelhund® Europa is the optimal solution for any transport thanks to the rubber buffer on all sides and the extremely antislip coating.

For order quantities of more than 50 pieces Cordes® customers receive the article with their name imprinted on it.



Möbelhund® Collector		Order No.
Dimensions: 700 x 740 mm	Hight: 2000 mm	mh-942.000
125 mm plastic rollers	Load cap. : 40 pcs.	



Möbelhund® Extra			Order No.
100G	Dimensions: 600 x 350 mm	Height: 145 mm	mh-934.000
	100 mm rubber wheels "no-trace"	Load cap.: 500 kg	

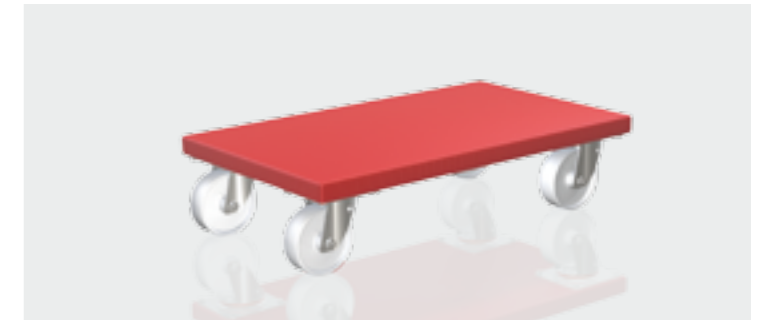

Möbelhund® Extra			Order No.
100K Light	Dimensions: 600 x 300 mm	Height: 140 mm	mh-951.200
	100 mm plastic rollers	Load cap.: 300 kg	
100K Light	Dimensions: 600 x 350 mm	Height: 140 mm	mh-951.201
	100 mm plastic rollers	Load cap.: 300 kg	
100K	Dimensions: 600 x 350 mm	Height: 145 mm	mh-934.000
	100 mm plastic rollers	Load cap.: 500 kg	
100K Maxx	Dimensions: 600 x 500 mm	Height: 145 mm	mh-934.113
	100 mm plastic rollers	Load cap.: 500 kg	
100K Maxx	Dimensions: 600 x 600 mm	Height: 145 mm	mh-934.112
	100 mm plastic rollers	Load cap.: 500 kg	
100K Maxx	Dimensions: 720 x 480 mm	Height: 145 mm	mh-934.200
	100 mm plastic rollers	Load cap.: 500 kg	
100K Maxx	Dimensions: 780 x 500 mm	Height: 145 mm	mh-934.207
	100 mm plastic rollers	Load cap.: 500 kg	
100K Maxx	Dimensions: 600 x 480 mm	Height: 145 mm	mh-934.319
	100 mm plastic rollers	Load cap.: 500 kg	
100K Maxx	Dimensions: 800 x 600 mm	Height: 145 mm	mh-934.306
	100 mm plastic rollers	Load cap.: 500 kg	
100K Maxx	Dimensions: 1040 x 600 mm	Height: 145 mm	mh-947.000
	100 mm plastic rollers	Load cap.: 500 kg	



Möbelhund® Europa			Order No.
100G	Dimensions: 600 x 350 mm	Height: 145 mm	mh-936.000
	100 mm rubber wheels "no-trace"	Load cap.: 500 kg	
100K	Dimensions: 600 x 350 mm	Height: 145 mm	mh-937.000
	100 mm plastic rollers	Load cap.: 500 kg	

→ **The Möbelhund®**

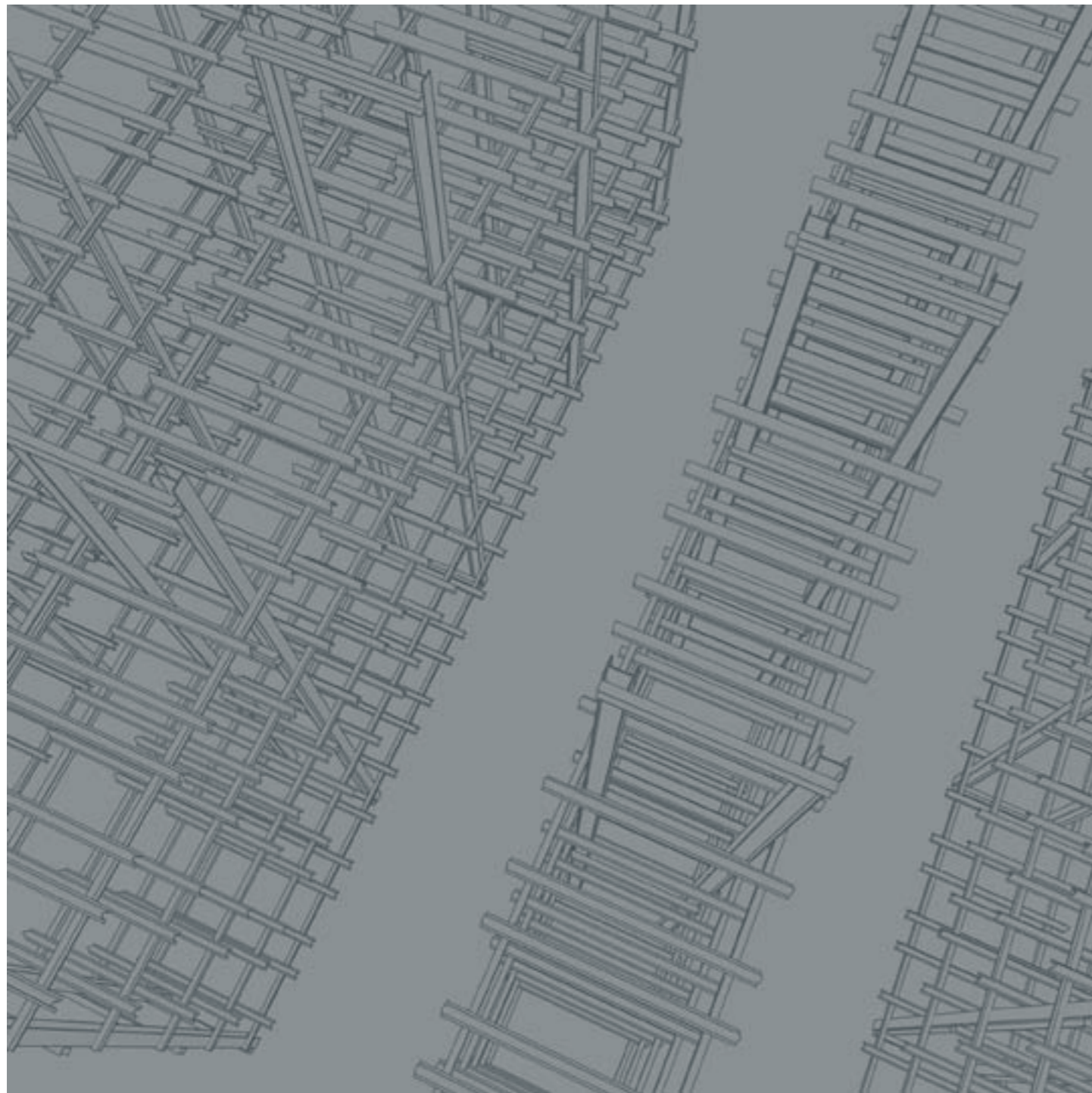

We plan for you. Cordes – your specialist for furniture logistics.

Planning a warehouse in such a way that it precisely meets one's own requirements and also takes into account future growth without great modifications is not an easy matter. Our specialized Planning Service makes it particularly easy for you.

We advise you on optimal utilization of your storage space with equal competence as in the selection of appropriate racks or electric transport equipment for your warehouse.

With the FurniBox® you not only get a tried and tested transport unit for your furniture, but also all important information on setting up your warehouse. By means of a special computer program, we develop jointly with you a layout that is tailored to your specific needs. Simply send us a ground plan and we will supply you with the perfect layout.

Put us to the test and profit from over 40 years of experience in furniture logistics.



→ Warehouse planning



Behind every strong brand is a strong manufacturer.

There are 40 years of manufacturing competence behind the FurniBox®, Cordes' core product for furniture logistics. For our customers this means: Cordes stands for perfected high-quality products and qualified consulting in the entire field of transportation and storage of furniture.

We produce exclusively in the EU and guarantee the top workmanship of every single FurniBox®. By virtue of meticulous quality control, we ensure that only flawless products are sent on their way to you. Furthermore, the refined Cordes logistics system always guarantees rapid and smooth delivery.



→ **This is Cordes**



→ Personalization

Just the way you want it. The FurniBox®.

No matter whether you want the FurniBox® narrower or wider, higher or deeper or in a special colour. You get it tailored precisely to your warehouse. The FurniBox® is not only available in any dimensions, but complete special designs on demand are also no problem at all. In addition, you can choose the side walls of your FurniBox® in different mesh sizes and adapt them individually to the desired type of loading in this way. The numerous well thought-out accessories, which Cordes has developed specially for the FurniBox®, make the FurniBox® even more efficient and the organization of your warehouse child's play.

Customized products and special designs?

No problem – Cordes has the matching production capacity and optimally trained specialists. With the FurniBox® you and your customers profit from the flexibility of an experienced manufacturer. Moreover, the high-quality paintwork can, of course, be applied in any colour you wish. With the FurniBox® you and your customers profit from the flexibility of an experienced manufacturer. In addition, the 3-year manufacturer's warranty vouches for the high quality of the FurniBox®. This means Cordes is your competent partner you can contact at all times.

Get in touch with us. We look forward to hearing from you



Special width

For special loads of furniture you can order the FurniBox® individually in desired widths.



Special height

For long items the FurniBox® is available in diverse special heights.



Special depth

For bulky pieces of furniture select the FurniBox® with the desired special depth.



Special equipment

The inside elements of the FurniBox® can be equipped with diverse horizontal or vertical subdivisions entirely according to your needs.



→ Big-name brands rely on FurniBox®

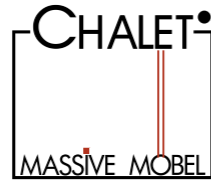

→ International vendors

No matter in what country, the FurniBox® is available worldwide!

Cordes is never far away from you. Through our partners and branch offices all over the world you always have a competent contact for your furniture and transport logistics in proven Cordes quality. In addition, our headquarters in Germany are, of course, at your disposal for all questions concerning furniture logistics at any time.

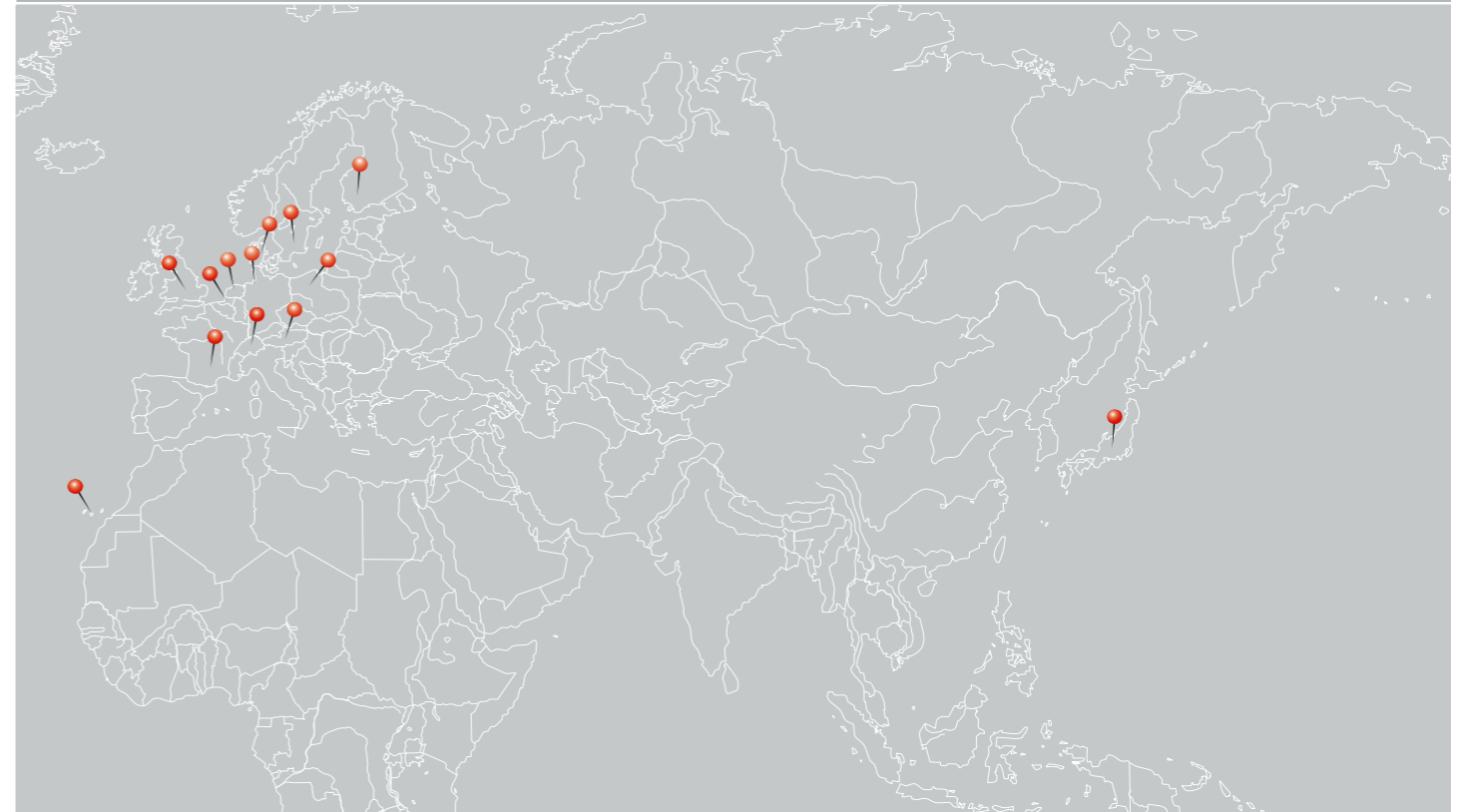

Belgium

DE RONDE & DRUBBEL N.V.
Ijzerlaan 7
B-2060 Antwerpen
phone: ++32 3-2250016
fax: ++32 3-2321803

France

Cordes France S.A.S
18 rue des Glaïeuls
F-67310 Wasselonne
phone: ++33 0388684731
fax: ++33 0388684864

Norway

BBI BAVARIA IMPORT A/S
Postboks 38, N-1556 Son
phone: ++47 64958635
fax: ++47 64958515

Switzerland

CORDES Schweiz GmbH
Feldacher 12
CH-6244 Nebikon
phone: ++41 627565428
fax: ++41 627562174

Denmark

DANSK NIELS BO
Vognmagervej 10, Snoghøj
DK-/7000 Fredericia
phone: ++45 75945800
fax: ++45 75945888

United Kingdom

Lift Safe LTD
Unit F, Prince of Wales Business
Vulcan Street, OL 1 4 ER Oldham
phone: ++44 1616269628
fax: ++44 1616269728

Austria

Gesa Transporttechnik Ing.
Gerhard Sandhofer GmbH
Hirschstraße 35
A-9020 Klagenfurt
phone: ++43 463341140
fax: ++43 46334254

Spain

Cordes Canarias S.L.
C/. Del Herraje
M3-Nave 27 - Pol. Ind. Arinaga
35119 Agüimes, Gran Canaria
phone: ++34 902195315
fax: ++34 902197483

Germany

CORDES GmbH & Co. KG
Weißenfelder Straße 1
D-21698 Harsefeld
phone: ++49 4164 816-0
fax: ++49 4164 5427

Holland

AARNOUDSE B.V.
Boerhaavelaan 21
NL-2992 KB Barendrecht
phone: ++31 180-616000
fax: ++31 180-617987

Poland

CORDES Polen
Sp. z o.o.u.l. Przemysłowa 17
PL-88-300 Mogilno
phone: ++48 52-3159-441/-442
fax: ++48 52-3159429

Finland

Effekta Oy
Hyljeveneentie 1 D 8
FIN-02260 Espo
phone: (09) 988162340
int. ++358 988162340
fax: (09) 988162345
int. ++358 988162345

Japan

KOSUGA & CO., LTD.
15-4, 2-Chome, Higashi-
Nihonbashi
JAPAN CHUO-KU, TOKYO
phone: ++81 338626725
fax: ++81 338626826

Sweden

MICROLOGISTIC AB
Kemistvägen 17
SE - 183 79 Täby
phone ++46 8 54 44 01 50
fax ++46 8 732 38 70

CORDES GmbH & Co. KG
Weißfelder Straße 1
D-21698 Harsefeld

Telefon ++49 4164 816-0
Fax ++49 4164 5427

Web www.cordes.eu
Email info@cordes.eu

